

APZ1-850

Shower drain with an edge for perforated grids

Application

- For wheelchair access
- For drainage of floor-level showers
- For installation into open spaces or near the wall of the shower area
- For perforated stainless steel grids
- For indoor use

Features

- The collar and trap are protected by foil, and the channel itself by a polystyrene insert
- Trap material: polypropylene
- Material of shower drain: stainless steel 2 mm, AISI 304, DIN 1.4301, EN1253-1
- Mechanically cleanable trap up to the waste pipe
- Possibility to buy a combined odour trap
- Linear drain from stainless steel (hardened by pickling, passivation and electrochemical polishing)
- Self-adhesive tape for quality waterproofing
- Trap firmly connected to the drain – 100% waterproofing
- Installation height from 85 mm
- Adjustable height
- The high flow rate is achieved due to the double compartment trap system
- 25 years guarantee

Scope of supply

- Fixation set: screws Ø6x50 – 2 pcs, dowels Ø10 – 2 pcs
- Installation trough cover - polystyrene
- Protective foil covering for the drain edges and odour trap
- Protective film for trap inlet
- Self-adhesive waterproofing tape
- The shower drain is assembled with the odour trap

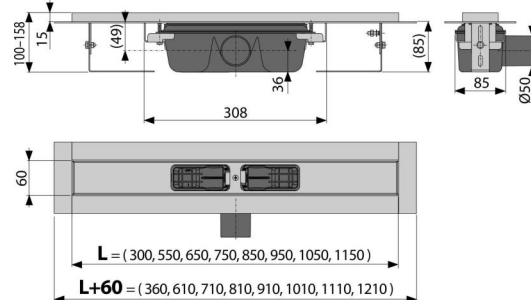

Order number, Logistic information

Code	EAN	Weight (piece packing palett)	Dimensions (piece packing)	Quantity (packing palett)
APZ1-850	8594045932942	850 mm 3,5651 42,7812 148,3436 kg	920x135x170 mm	12 36 pcs

Warranty	Customs code	Norms
2/25 years *	39229000	EN 1253

Technical specifications

- Total installation height 100-158 mm
- Minimum thickness of concrete 85 mm
- Resistance of odour trap against the pressure 982 Pa
- Waste pipe diameter 50 mm
- Flow rate 60-68,8 l/min
- Load class K3 300 kg
- Odour trap 50 mm