

H1: 0	- factory settings restoration: 0-No, 1-Yes. To restore factory settings set H1=1. Process is signalled by command indicated on the display:
H2: 0	- memory reset: 0-No, 1-Yes. To reset the memory set H2=1. Memory deletion process is signalled on the display:
H3: 0	- password, range 0..99. Access to the configuration menu can be password protected 0 - password off; 21 - emergency password.

9.4. PARAMETERS EDITION

Recorder operates on 8-segmental LED display. The edition of alphabetic and digital marks in these parameters is possible due to the following character table:

Caption:

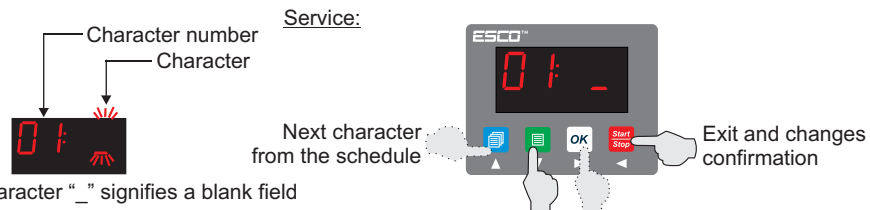

Character map:

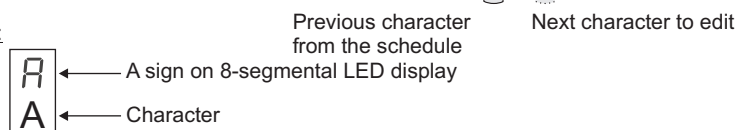

_	A	b	C	d	E	F	G	h	I	J	K	L	M	N	O	P	Q	R	S
None	A	B	C	D	E	F	G	H	I	J	K	L	M	N	O	P	Q	R	S
t	U	V	W	X	Y	Z	1	2	3	4	5	6	7	8	9	0	-	.	_
T	U	V	W	X	Y	Z	1	2	3	4	5	6	7	8	9	0	-	.	None

10. REPORT PRINTOUT.



10.1. BRIEF REPORT.

To print the report press  button

The type of brief report can be set in P7 parameter in “Others” group:



- actual measurements (current recorder measurements)
- from the delivery (from the last delivery, from loading to unloading)
- from the last hour
- from current day

10.2. FULL REPORT.

To start the printout press  button. To stop the printout at any moment press  button again. In this mode, the recorder prints all data from the memory from the newest measurements to the oldest. By means of this function you can print data from any period of time, from the beginning of the printout stopping data printing at any moment.

10.3. REPORT FROM GIVEN PERIOD OF TIME.

In this mode, recorder prints data from the specified period of time.

Press  button to enter the menu and select “print from”  and enter with  button.

Enter **the beginning** of the printing period (year/month/day/hour/minute).

Then “print to” command display  and enter with  button.

Enter **the end** of the printing period (year/month/day/hour/minute).

Recorder prints the report and exits from the configuration menu 

ESCO™

DR-201

TEMPERATURE RECORDER



Version 1.0

USER MANUAL / WARRANTY

1. TECHNICAL CHARACTERISTICS.

DR-201 is the temperature recorder with built-in printer designed to be installed in the cab, both in heavy lorries and small delivery vans. Due to small size and compact design is ideal for daily use. The device is mounted on the dashboard due to included fixing clamps. Power supply and temperature sensor are connected with connectors to the rear panel.

Recorder has included:

- two temperature sensors
- cable for connecting the door opening sensor
- distributor
- feeding cable with a fuse

The recorder has a memory buffer for 62000 measurements (lasts for 2 years at a frequency of memorizing every 15 minutes). The frequency of data memorizing to the memory can be set from 1 to 999 minutes. The device operates in two modes:

- continuous recording,
- recording during the drive.

In the second case, recording process turns on/off with START/STOP button, which marks the beginning and the ending of the drive at the same time. When operating, the recorder indicates the temperature from the first and the second sensors alternately and the current time. The mode of recording and duration of the drive is indicated by LED diodes. Additionally, the driver can set MIN and MAX temperature alarms which, when exceeded will be stored in memory and signalled acoustically. The stored data can be deleted and the access to the menu can be password-protected. Due to built-in thermal printer, it is possible to print data from the memory from any period of time.

2. SPECIFICATIONS

Inputs:	2 temperature sensors: NTC 5k Ω by 25°C 1 logical inputs (normally closed or opened)
Measuring range:	NTC: -40...+120°C
Accuracy:	NTC in: -40...+80°C range: $\pm 0,5^\circ\text{C}$, in other $\pm 1^\circ\text{C}$
Memory cache:	62 000 measurements, non-volatile memory
Data memorizing frequency:	1min...24hours.
Display resolution:	0,1°C in whole range
Display:	LED with graphic icons
Printer:	thermal, printing speed 50mm/s, heat-sensitive paper 57mm width, roll diameter 40mm
Protection class:	IP-30
Power supply:	12...24VAC/DC $\pm 20\%$
Power consumption:	when recording 40mA, when printing - to 3A
Operation and storage conditions:	operation: -20...50°C; storage: -40...60°C

3. REAR PANEL.

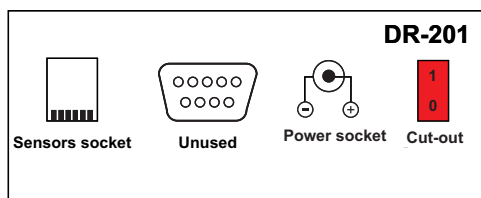

9.3 DESCRIPTION OF THE PARAMETERS:

dr od dr do	Print from/print to - recorder allows you to print a report from the specified period of time. You should enter the beginning and the ending of the printing period.	
date	date - current date	
time	time - current time	
OP IS	Description - in the report header you can place a brief description of the user, e.g. business data, company address (maximum 32 figures, figures edition, see: point 9.4)	
nr ED	Registration number - in the report header you can place the registration number of the vehicle (maximum 32 figures, figures edition, see point. 9.4)	
ALAR	alarm - The user can activate the temperature alarm function and set the lower temperature alarm d-40 and upper temperature alarm 0 99 for each sensor. When exceeding the limit, the user will be informed by a message on the display and beeper. When an alarm occurs, you can mute the beeper by pressing any configuration button. Occurred emergency states will be recorded in the device memory and marked on the printout. Parameter OP 3 determines an alarm switching delay in minutes.	
Prob	Sampling - This parameter allows you to set the data sampling time in 1min...24hours range. (The frequency of memorizing data to the recorder memory).	
InnE	Other parameters:	
P0	- sensor T1: 1-ON, 0-OFF	
P1	- sensor calibration T1, range: -9..9°C When the temperature value deviates from the actual value, you can calibrate the temperature sensor. The parameter value is added to the measured value.	
P2	- sensor T2: 1-ON, 0-OFF	
P3	- sensor calibration T2, range: -9...9°C	
P4	- logical input: 0-off, 1-on (NO), 2- on (NC), 3-delivery function Thermograph is equipped with two logical inputs for events recording (door opening, unit operation, defrosting cycles) or to carry out the "delivery" function. Commands "loading" and "unloading" in a "delivery" function are triggered by shorting signal. Connect a shorting signal to a wire, e.g. Ordinary doorbell button. Shorting the circuit commands will be activated and stored in the recorder memory. "Delivery" command is signalled on the display by LED diode	
P5	- beeper: 1-ON; 0-OFF	
P6	- display blanking after a period of inactivity, range 0...99sec. P6=99 - display blanked constantly, P6=0 - display does not blanking	
P7	- brief report printout type by pressing button 0-actual measurements, 1-delivery report, 2-last hour report, 3-current day report	
P8	- recording mode: 1-CONTINUOUS - saving data continuously - diode signalling REC - the moment of the beginning and of the drive: "loading" and "unloading" are triggered by button (diode signalling the delivery).	0-ONLY DURING DRIVE - saving data only during the drive - to start the drive and immediately activates recording press (diode signalling the delivery, and diode REC signalling recording).
P9	- language: 0-polish; 1-english, 2-german	

9. RECORDER CONFIGURATION.

After recorder and measuring sensors mounting correctly, plug in the power and configure the device.

9.1. MENU HANDLER.

OK ▶ - starts menu and parameters edition and accepts changes

▲ **Copy** ▼ **Print** - changes the parameters values and passes between them

Start Stop ◀ - backs up one level higher in the menu nad exits from the configuration menu, it is also used to go back to the previous character edition

9.2. MENU DIAGRAM.

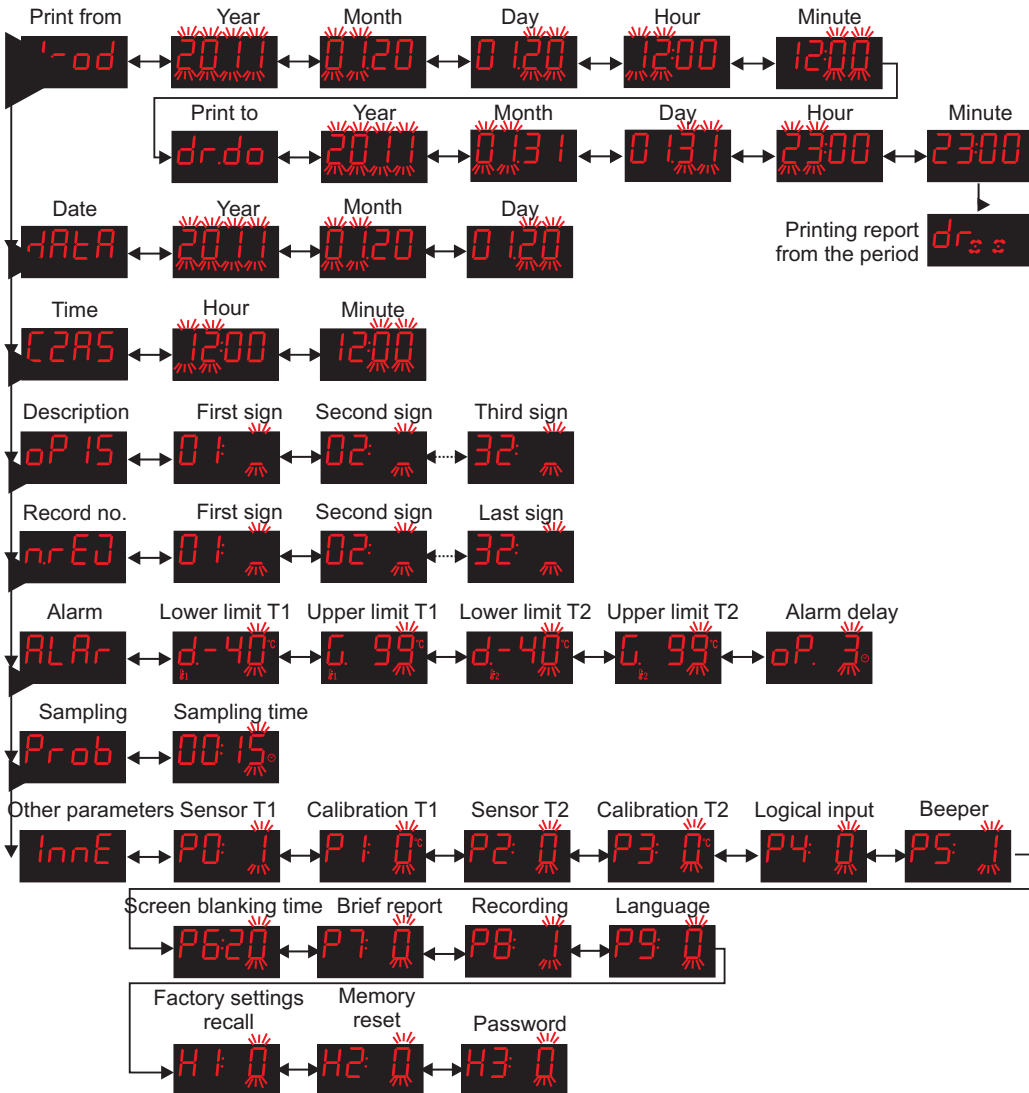

4. MOUNTING.

Recorder.

When choosing an assembly location you have to remember that the casing of the recorder is non resistant to difficult environment conditions. Therefore, it should be mounted inside the vehicle cabin. Included fixing clamp allows you to adjust the angle of attachment to the vehicle dashboard, clipboard or bulkhead. An assembly location must provides comfort in daily use.

Loosen the lower clamp screws (Pic. 2 point 2) and unscrew side cap nuts (Pic. 2 point1) and remove the fixing clamp (Pic. 2 point 3). Fit the clamp to the dashboard and mark the holes. Then drill the holes with diameter of 3mm and fasten with screw with diameter of 3,5mm. Mount the recorder back on the clamp and adjust the angle of slope so that it resists in the front of the dashboard. Then tighten the cap nuts (1) and lower chuck screws (2).

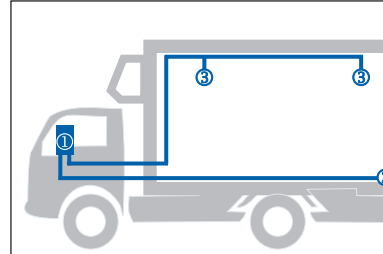

- ① Recorder DR-201
- ② Door opening sensor
- ③ Temperature sensor

Pic.1 The example of recording system in the truck.

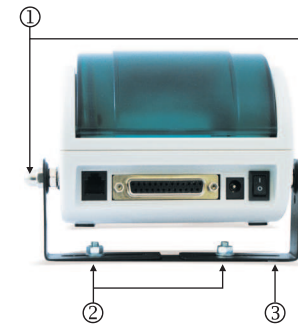

Pic.2 Fixing clamp (3).

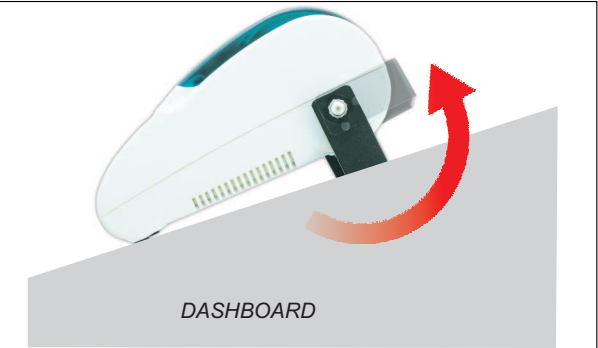

Pic.3 Choice of angle to the dashboard.

Wiring.

Recorder is equipped with:

- two temperature sensors
- cable for connecting the door opening sensor
- feeding cable with fuse socket

All sensor wires are terminated with standard RJ-11 connectors.

Temperature sensors:

Temperature sensors should be installed in cold chamber in a safety place, not exposed to mechanical damage, where is a proper air circulation. The source of indoor lighting should not be closer than 50cm from the sensors. The recommended location of the sensors is on the wall, 30cm of the ceiling, properly 1/3 and 2/3 of the chamber length from the outlet of the evaporator. The sensor is mounted in a vertical position with an ending upwards, directly on the wall inside the chamber by means of clamps and fixing chucks.

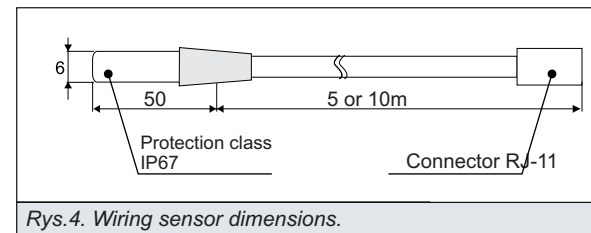

Rys.4. Wiring sensor dimensions.

Temperature sensor are marked by "1" and "2" numbers. The sensors does not require wiring polarity. To extend the sensors use standard OMY wires with a section not less than 0,5mm². Maximum wire length should not exceed 100 meters depending on quality and section of used wire.

Door opening sensor:

Thermograph has a logical input for events recording (doors opening, defrosting cycles, unit operation, loading and unloading time recording). The wire to connect the event sensor is included (e.g. Reed door sensor). The type of event sensor is specified by P4 parameter in the "Others" (NC - normally closed/ NO - normally opened). When connecting contacts signalling the unit operation or defrosting cycle to the digital input, you should make sure that no signalling circuit is not a live both in active and inactive state! Otherwise, the recorder will break down. Signalling relies on short-circuiting or digital input circuit opening, rather than the charge transfer!

Each closing and opening the circuit will be recorded in the recorder memory. The sensor does not require wiring polarity.

Power supply.

The recorder is powered by the vehicle wiring system 12V and 24V. It is possible to connect the recorder directly from the accumulator, fuse strip or the lighter socket. The feeding cable is equipped with a 5A fuse socket with (+) and (-) marks. Maximum power consumption (when printing) is 40W. When recording, the power consumption is negligible, about 40mA.

5. DIAGRAM OF CONNECTING RECORDER with one temperature sensor.

If the recorder is installed in a small delivery van and the user uses only one temperature sensor, it is possible to opt out of the distributor and connect the sensor no. 1 to the recorder directly as follows:

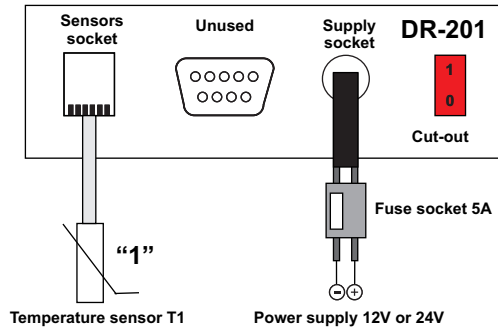

6. DIAGRAM OF CONNECTING RECORDER with two temperature sensors.

If the user uses two temperature sensors, it is necessary to use the distributor:

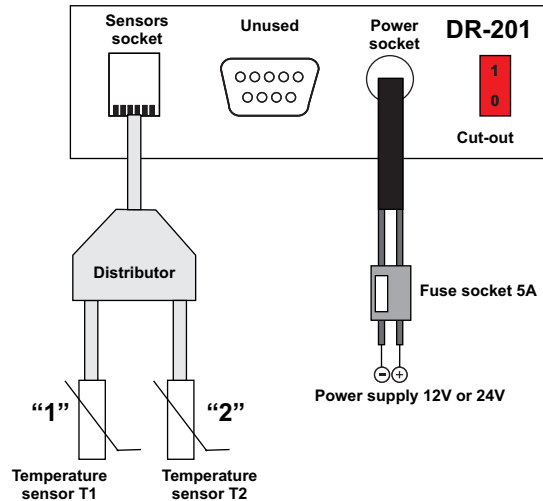

7. FRONT PANEL.

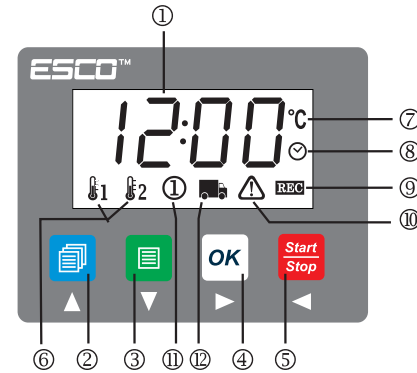

- ① Display
- ② Full report printing button
- ③ Brief report printing button
- ④ Confirming key, it is also used for configuration menu start-up
- ⑤ Delivery and changes cancellation button, pressing for 5 sec turns on/off recording
- ⑥ Temperature sensor number
- ⑦ Temperature indicator
- ⑧ Time indicator
- ⑨ Temperature recording runs
- ⑩ Temperature alarm or temperature sensor failure
- ⑪ Logical input activation (for example, door opened)
- ⑫ Delivery of goods (drive lasts)
- ⑬ Power supply indicator
- ⑭ Out of paper alarm
- ⑮ Paper eject button

8. PAPER INSTALLATION.

Put an included roll of thermal paper in the printer. The thermal paper used for printing is standard and available in every stationery point of sale. It is recommended to use rolls of a width of 57mm and diameter of 40mm.

How to install the paper:

1. Open the printer cover (pull the cover up on both sides of the printer: look at the fibula on the picture)
2. Put the roll of paper in the printer
3. Pull out about 3cm of paper outside the cover
4. Close the cover of the printer so that the paper came out correctly through the output hole.
5. If it is necessary pull out the paper using "FEED" button

ATTENTION:

Thermal paper is "unilateral" and has to be mounted from the correct side in the printer. If the print-out is "empty", reverse the paper to the other side.